



# MBK-280ZL-W

Suport "ZL" pentru prindere electromagnet

## Imagine



YLI ETERNIT ACCES SRL  
A.: HAIDUCULUI 3A, CLUJ-NAPOCA  
T.: +40 264 484989  
W.: WWW.YLI.RO

MBK-280ZL-W  
Suport "Z", "L" pentru electromagnet  
FISA TEHNICA

## Descriere

MBK-280ZL-S este un suport in forma de „Z” si „L” pentru montarea electromagnetilor YM-280W-S pe usi cu deschidere la interior.

## Specificatii

- Material: Aliaj de aluminiu
- Tip: Suport „Z”, „L”
- Instalare: Aplicata
- Compatibilitate: YM-280W-S
- Tip usa: Lemn, metal, PVC

## Instalare

1. Fixati suportul „L” de tocul usii
2. Prindeti electromagnetul de suportul „L”
3. Fixati partea inferioara a suportului „Z” de foaia de usa
4. Atasati partea superioara a suportului „Z”
5. Prindeti contraplaca electromagnetului de suportul „Z”

## Dimensiuni

### Suport "Z"

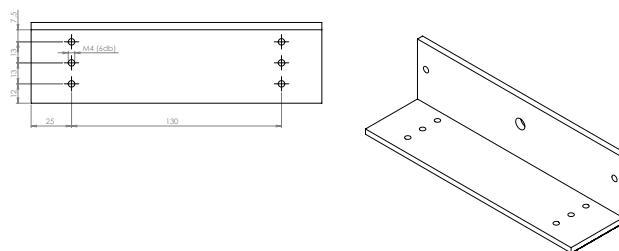
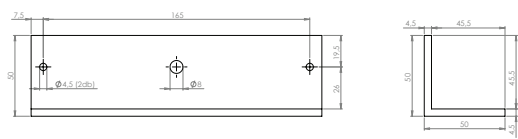
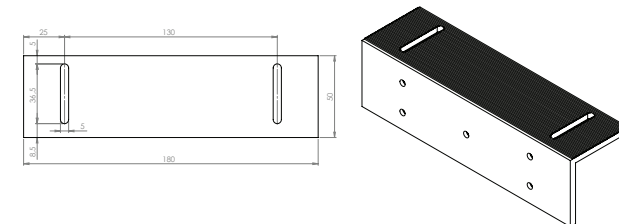
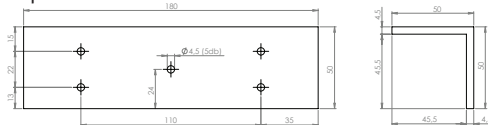

### Suport "L"

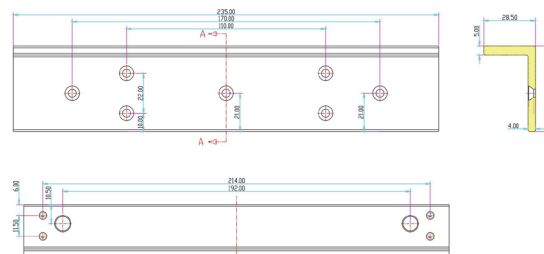

## Schema de instalare

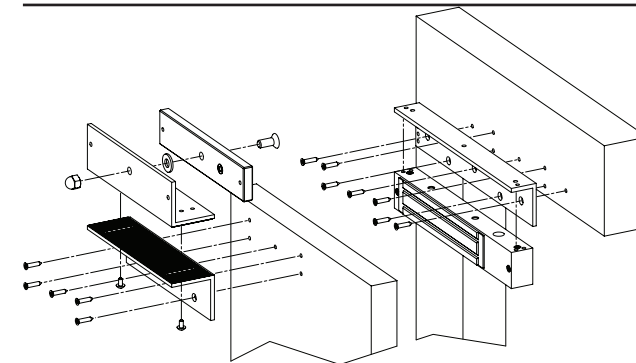

## Schema de asamblare

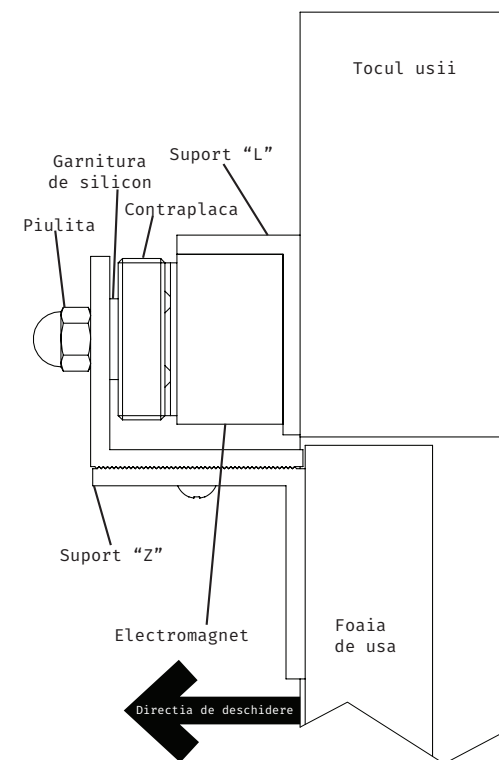

## Observatii



EEE FAC OBIECTUL UNEI  
COLECTARI SEPARATE