



SN-IPR56/20AKDN/T/ZI

Camera IP LPR cu recunoastere numere si control bariera auto, ANPR integrat

Imagine



Descriere

Camera SN-IPR56/20AKDN/T/ZI este o solutie de tip "ALL-IN-ONE" dotata cu iluminator IR de mare putere ce permite automatizarea accesului prin barierele auto fara a necesita software sau hardware extern. Aceasta include doua liste de numere de inmatriculare (black list & white list), pe baza carora se poate activa releul intern al camerei, incarca o captura a placutei de inmatriculare pe un server FTP sau ambele simultan. Datorita tehnologiei FLASH si ActiveX poate fi accesata din toate browserele ce suporta aceste tehnologii. Contactul releului intern al camerei poate fi conectat direct la comanda de deschidere a barierei, obtinandu-se astfel un sistem de control al accesului auto simplu, fiabil si usor de implementat.

Camera este compatibila pe deplin cu standardul ONVIF putand fi integrata cu usurinta in sistemul de monitorizare al companiei. Numerele recunoscute sunt suprapuse peste imaginea camerei si inregistrate in acelasi timp cu imaginea camerei pe un sistem NVR sau NVMS. Camera mentine un istoric de evenimente ce poate fi consultat utilizand interfața web integrata a camerei.

Produsul este ideal pentru sistemul de management al vehiculelor pentru parcuri, cladiri de birouri, shopping center.

Caracteristici



- Senzor imagine 1/2.9" Progressive Scan 2MP CMOS
- **Lentila 3-12 sau 7-22 mm MOTORIZATA** (2 modele disponibile)
- Rata de recuoastere de 97% sau mai mare
- Viteza maxima de recunoastere 50 km/h
- Sensibilitate ridicata la lumina 0.1 Lux/F1.8, 0 Lux(IR LED On)
- dWDR pentru situatii de supraexpunere si zone intunecate
- Protectie la intemperii IP66

Functionare

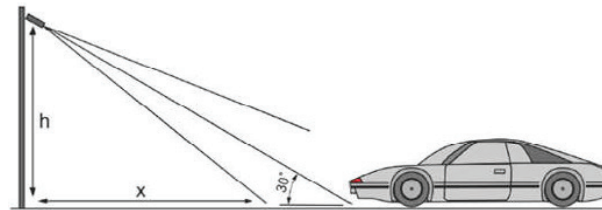
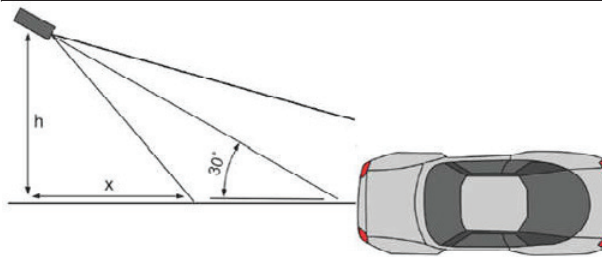

Software

Live Video | Playback | Configuration

Time	License Plate Number	License Plate Image	Action	List	Country
2017-2-14 13:53:30	KD5ALCE		No Action	Not in List	GBR
2017-2-14 13:53:36	CJ8PFW		No Action	Not in List	ROU
2017-2-14 13:53:22	CJ8MRK		No Action	Not in List	ROU
2017-2-14 13:53:19	CJ8GRUA		No Action	Not in List	ROU
2017-2-14 13:53:14	CJ8MFO		No Action	Not in List	ROU

Specificatii

- Senzor imagine 1/2.9" Progressive Scan, 2MP CMOS
- Capacitate numere 500 black list, 500 white list
- Iluminare minima Color 0.01 Lux, IR ON 0 Lux
- Lentila/Iris 3-12 sau 7-22 mm MOTORIZATA, FOV 87.8°~ 31.7°(H) / MOTORIZAT, FOV 40.7°~ 16.8°(H) / MOTORIZAT
- Iluminator IR SMART IR, 17 x LED SuperFlux, 30-40m, 60-70 M (Auto/Manual)
- Wide Dynamic Range dWDR
- Reducere digitala zgomot 2D/3D
- Compresie video H.264 (Base, Main, High Profile), MJPEG
- Compresie audio G.711, RAW_PCM
- Rata biti (CBR/VBR) Main stream: 500-12000kbps, Sub stream: 100-6000Kbps
- Rezolutie maxima 1920*1080/30fps
- Stream Stream1: 1920x1080, Stream2: D1 / 640*360
- Setari imagine Rotatie, Saturatie, Luminozitate, Contrast, Claritate
- Functii BLC, HLC, WDR, DIS, De-Fog, WB, AES, Mod Coridor, ROI
- LPR Integrat (latime min. nr: 130px)
- Numere suportate EU, CIS
- Rata recunoastere 97% sau mai mare
- Viteza maxima max. 50 km/h
- Afisare in OSD Data/Ora capturii, numarul de inmatriculare
- Liste acces Alba/Neagra (500 nr. per lista) cu activare releu
- Protocoale retea HTTP, HTTPS, RTSP, DHCP, NTP, PPPoE, Unicast si Multicast
- Compatibilitate ONVIF, CGI
- Retea 1 conector RJ-45, 10/100 Base-T
- Porturi I/O Alarma I/O, Audio I/O, lesire video BNC
- Stocare MicroSD Micro SD/SDHC slot, Max64GB
- Alimentare 12Vcc/POE
- Consum 5W (IR LED OFF), 8W (IR LED ON)
- Temperatura operare -30° ~ +60°C
- Protectie intemperii IP66
- Dimensiuni 377(L) x 110(Φ) mm
- Masa 1.68 kg

YLI ETERNIT ACCES SRL
 A.: HAIDUCULUI 3A, CLUJ-NAPOCA
 T.: +40 264 484989
 W.: WWW.YLI.RO

SN-IPR56/20AKDN/T/ZI
 Camera IP LPR cu recunoastere numere
 si control bariera auto, ANPR integrat
 FISA TEHNICA



YLI ETERNIT ACCES SRL
 A.: HAIDUCULUI 3A, CLUJ-NAPOCA
 T.: +40 264 484989
 W.: WWW.YLI.RO

SN-IPR56/20AKDN/T/ZI
 Camera IP LPR cu recunoastere numere
 si control bariera auto, ANPR integrat
FISA TEHNICA

Caracteristici

ANPR INTEGRAT

Nu necesita software suplimentar sau hardware extern.

CONTROL BARIERA INCORPORAT

Comanda deschidere bariera direct din camera utilizand releu incorporat.

REGIUNI

Recunoaste toate tipurile de placute de inmatriculare din EU,



SN-IPR56/20AKD-

OPERARE SIMPLA

Adaugare numere de inmatriculare din interfata WEB (1000 de numere)

ONVIF

ACURATETE

Rata recunoastere mai mare de 97%, la viteze de pana la 80 km/h

FUNCTIONARE STABILA IN TOATE MEDIILE

IP66 si IK10, -40°C-+60°C
Putere IR ajustabila

CALITATE SI CLARITATE FULL HD

Senzor 1/2.9" CMOS cu scanare progresiva
Lentila motorizata: 3-12 / 7-22 mm
WDR, HLC, DNR si EIS (stabilizare electronica)

Instalare

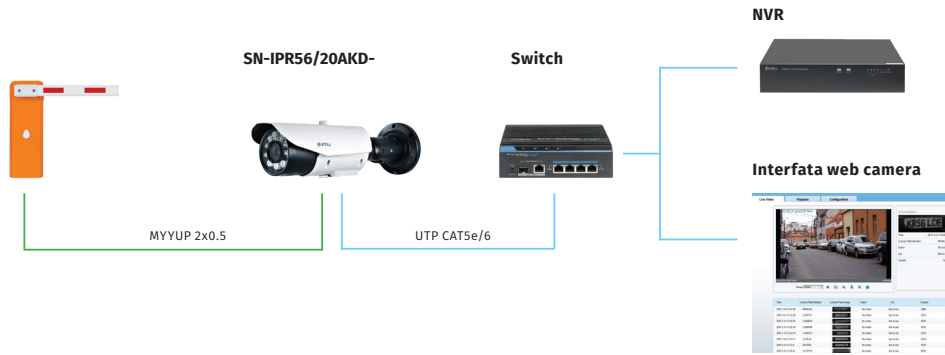

Aplicatii

COMPLEX REZIDENTIAL

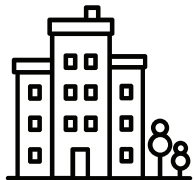

PARCARI



CLADIRI DE BIROURI

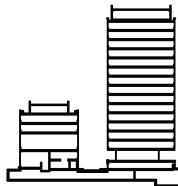

Parti si functii

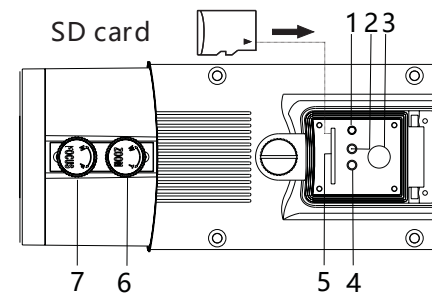

1. Buton Reset
2. Indicator retea
3. Mufa BNC
4. Indicator card SD
5. Slot card SD
6. Buton Zoom
7. Buton Focus

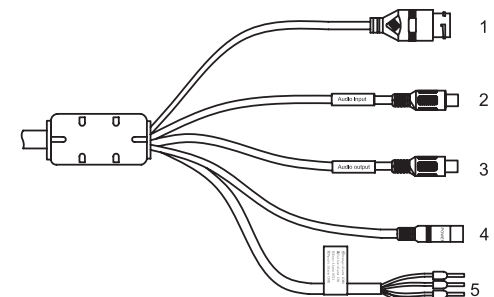

1. Mufa RJ45
2. Port intrare Audio
3. Port iesire Audio
4. Alimentare 12 Vcc
5. Gri-iesire alarma (NO)
Violet-iesire alarma (COM)
Galben-intrare alarma (NO)
Orange-intrare alarma (COM)

Dimensiuni

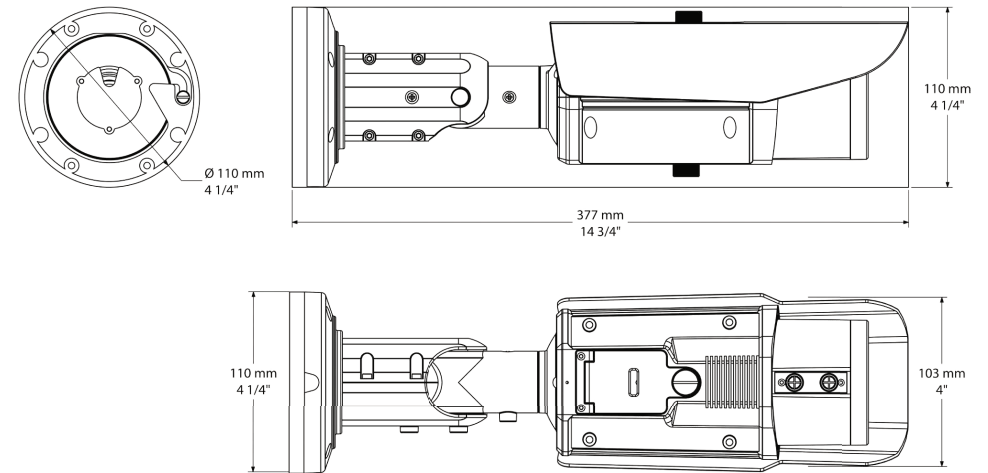

*Toleranta: ± 5mm

Observatii



EEE FAC OBIECTUL UNEI
COLECTARI SEPARATE

