



YHT-400S-45

Maner tragator din inox cu fixare la 45°, profil patrat

Imagine



YLI ETERNIT ACCES srl
A.: HAIDUCULUI 3A, CLUJ-NAPOCA
T.: +40 264 484989
W.: www.yli.ro

YHT-400S-45
Maner tragator din inox cu fixare la 45°,
profil patrat
FISA TEHNICA

Descriere

YHT-400S-45 este un maner din inox cu fixare la 45°. Manerul are forma patrata cu dimensiunea de 30 x 30 [mm] si lungimea de 400 [mm]. Se vinde la bucata.

Specificatii

• Material:	Inox
• Finisaj:	Inox satinat
• Forma:	Patrata
• Fixare la:	45°
• Grosime foaie de sticla:	5-50 [mm]
• Lungime:	400 [mm]
• Dimensiuni:	30 x 30 [mm]
• Interax:	210 [mm]

Dimensiuni

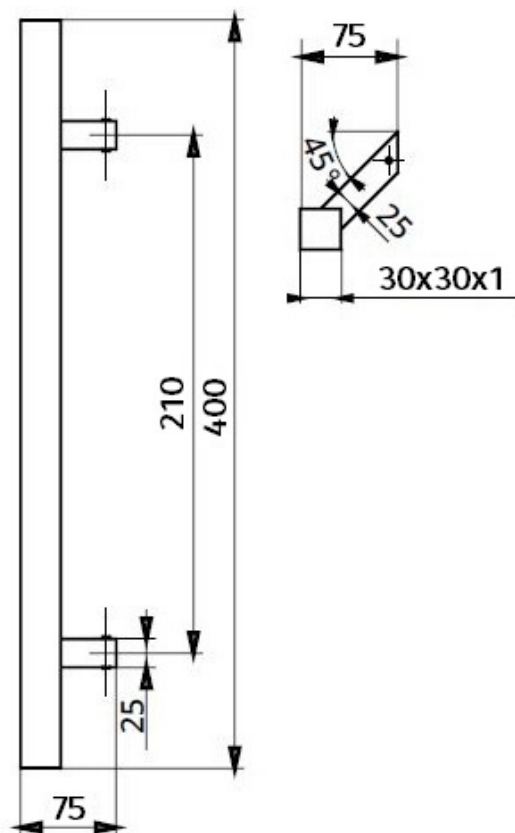

Schema de instalare

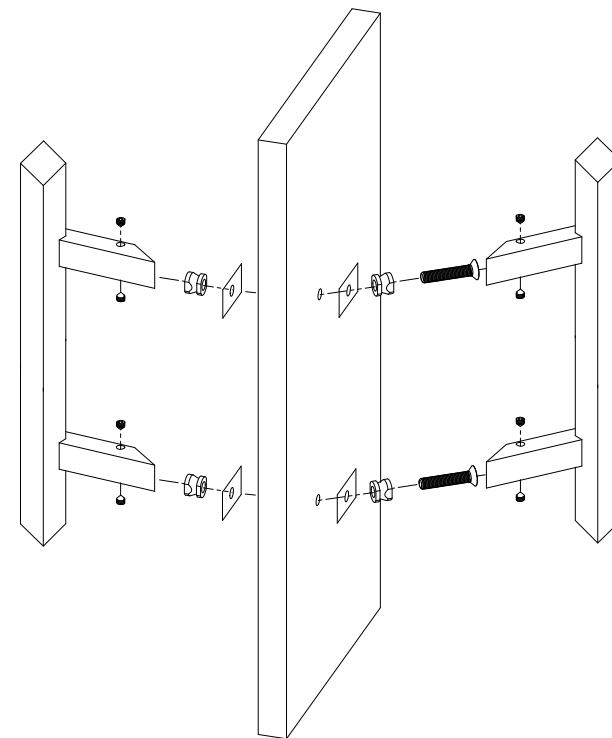

Observatii



EEE FAC OBIECTUL UNEI
COLECTARI SEPARATE

