



K2-1

Buton de iesire cu infrarosu si LED de stare bicolor cu montare incastrata

Imagine



YLI ETERNIT ACCES SRL
A.: HAIDUCULUI 3A, CLUJ-NAPOCA
T.: +40 264 484989
W.: www.yli.ro

K2-1
Buton de iesire cu infrarosu si LED de stare bicolor cu montare incastrata
FISA TEHNICA

Descriere

K2-1 este un buton de iesire cu infrarosu si LED de stare bicolor cu montare incastrata. Actionarea butonului se face prin simpla apropiere a degetului, nefiind necesara atingerea acestuia. LED-ul este albastru in stand-by si verde la actionare. Poate fi utilizat in sisteme de control acces, pentru deschiderea/ inchiderea usilor cu incuietori electrice. Pachetul include butonul si doua holsuruburi de fixare.

Caracteristici

- Alimentare: 12-24Vcc
- Iesire contact: NO-COM-NC
- Tensiune/curent maxim: 30Vcc/3A, 220Vcc/3A
- Functionare: Monostabil
- Actionare: Infrarosu, fara atingere
- Distanta de actionare: <20cm
- Testat la: 500.000 de actionari
- LED stare bicolor: Albastru, verde
- Montare: Incastrat
- Material: Inox + ABS
- Aplicabilitate: Interior/ exterior ferit de apa
- Dimensiuni: 86(H) x 86(L) x 21(A) mm
- Temperatura: -20°C ~ +55°C
- Umiditate: 0~95%, fara condensare
- Masa bruta: 0.1kg

Dimensiuni

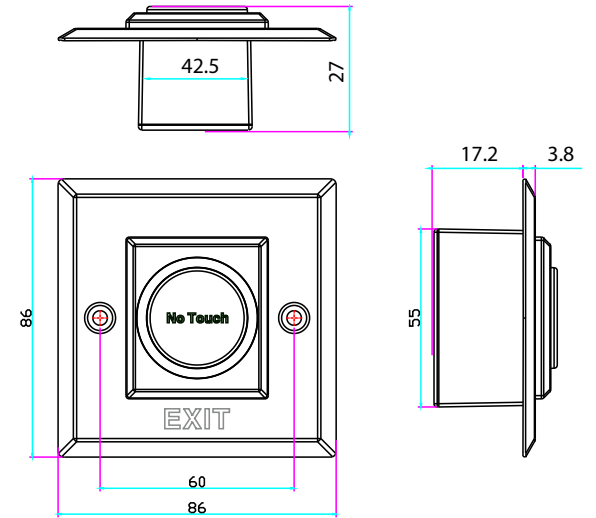

Conexiuni electrice

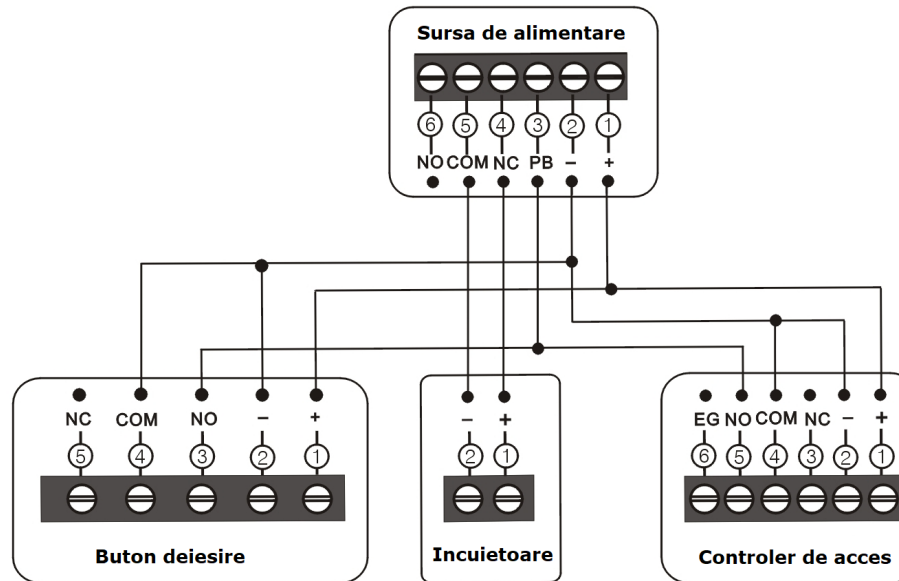

Observatii



EEE FAC OBIECTUL UNEI
COLECTARI SEPARATE

