



DH850P/F

Post de apel video IP pe 2-fire cu ecran TFT 5" si cititor RFID dual 125kHz / 13.56MHz

Imagine



YLI ETERNIT ACCES srl
A.: HAIDUCULUI 3A, CLUJ-NAPOCA
T.: +40 264 484989
W.: www.yli.ro

DH850P/F
Post de apel video IP pe 2-fire cu ecran TFT 5"
si cititor RFID dual 125kHz / 13.56MHz
FISA TEHNICIA

Descriere

Post de apel video IP din seria DH, cu comunicatie pe 2 fire fara polaritate. Camera cu lentila fisheye, 2MP Starlight, cu unghi de vizualizare de 170°, permite o identificare mai usoara a vizitatorului, iar LED-ul cu senzor automat asigura imagini color chiar si pe timp de noapte. Dispune de ecran TFT de 5" touch si cititor dual de carduri 125kHz si 13.56MHz incorporat. Selectarea locatarilor se face din agenda afisata pe ecranul TFT sau prin introducerea numarului alocat locatarului. Sistemul suporta maxim 64 de monitoare. Montaj aplicat (DH850P) sau incastrat (DH850F).

Caracteristici

- Camera cu lentila fisheye cu unghi de deschidere de 170°
- Senzor pentru iluminare automata
- Montare aplicata (DH850P), incastrata (DH850F),
- carcasa Inox, aparatoare de ploaie
- Cititor de proximitate RFID 125Khz si 13.56 MHz
- Inrolare maxim 320 de utilizatori
- Ecran TFT de 5" color, cu TouchScreen
- Lista cu nume pentru apelare usoara
- Led pentru vizualizare pe timp de noapte
- Protectie la intemperii IP65
- Iesire pentru yala electrica
- Compatibil cu monitoarele 2Easy DH si DT (cu DXG)

Specificatii

- Alimentare: 20 ~ 28Vcc (BUS)
- Consum: 96mA ~ 142 mA
- Camera video: 2MP Starlight, unghi 170° (H)
- Ecran: 5" TFT color, 800 x 480 px
- Temporizare yala: 1-99 secunde
- Alimentare yala: 12V, max 300mA (NO/NC)
- Temperatura: -10°C ~ +50°C
- Cablare: 2 fire (fara polaritate)
- Distanta fata de sursa: 75m max.
- Protectie intemperii: IP65
- Material: Otel inoxidabil
- Dimensiuni: 281(H)x110(L)x44(A)mm (DH850P)
316(H)x133(L)x46(A)mm (DH850F)

Cablare

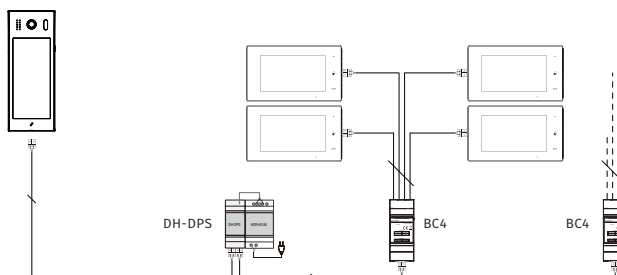

Parti si functii

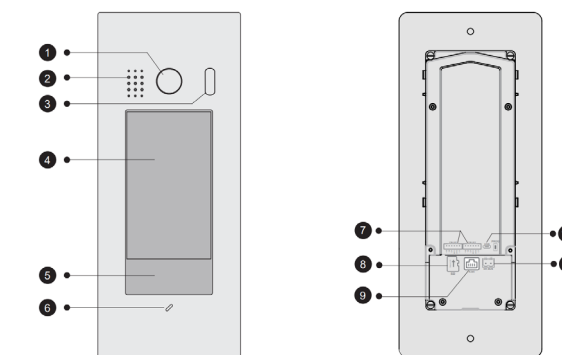

- | | |
|-------------------|---------------------|
| 1 Lentila camerei | 7 Port de conexiuni |
| 2 Difuzor | 8 Slot SD CARD |
| 3 LED camera | 9 Conector RJ45 |
| 4 Ecran LCD | 10 Conector USB |
| 5 Cititor carduri | 11 Conector BUS |
| 6 Microfon | |

Descriere terminale

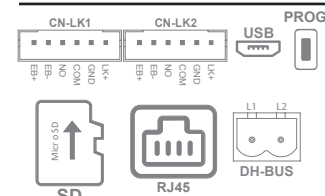

- **DH-BUS:** Magistrala BUS TCP/IP (fara polaritate)
- **RJ-45:** conectare la retea (rezervat)
- **SD:** slot microSD
- **PROG:** buton programare
- **USB:** conector USB upgrade firmware
- **LK1/LK2:** conector yala 1, yala 2
- **EB+:** Buton de iesire +
- **EB-:** Buton de iesire -
- **NO:** Contact releu normal deschis
- **COM:** Contact releu comun
- **GND:** Masa (Vcc-)
- **LK+:** alimentare yala (+12 Vcc)

Observatii





Distante si capacitate sistem

YLI ETERNIT ACCES srl
 A.: HAIDUCULUI 3A, CLUJ-NAPOCA
 T.: +40 264 484989
 W.: www.yli.ro

DH850P/F
 Post de apel video IP pe 2-fire cu ecran TFT 5"
 si cititor RFID dual 125kHz / 13.56MHz
FISA TEHNICIA

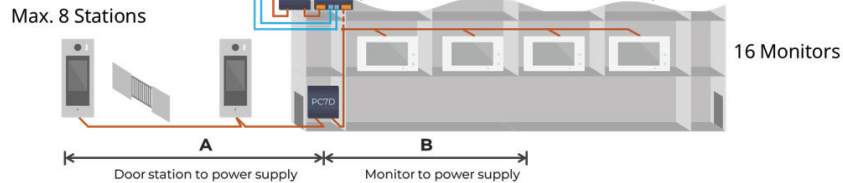
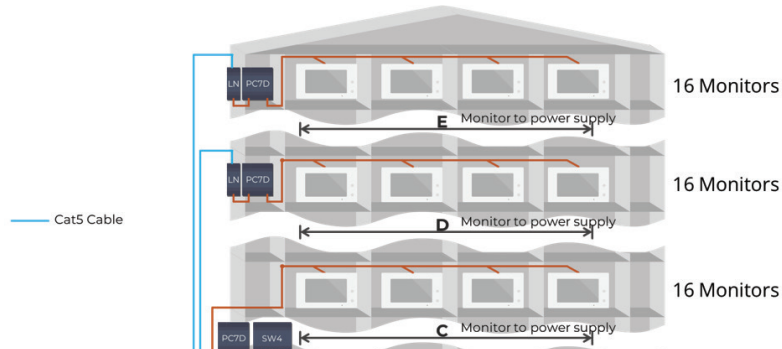
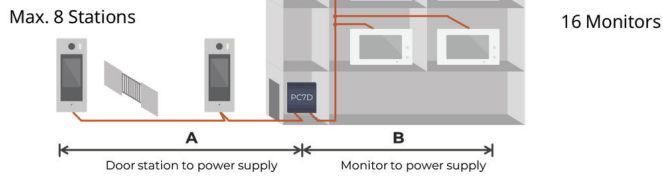
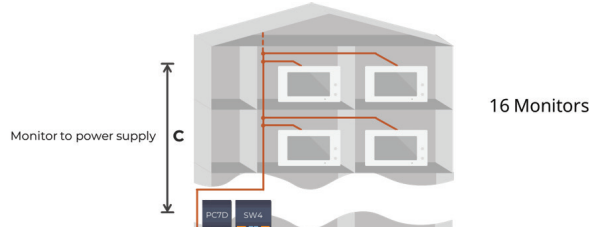
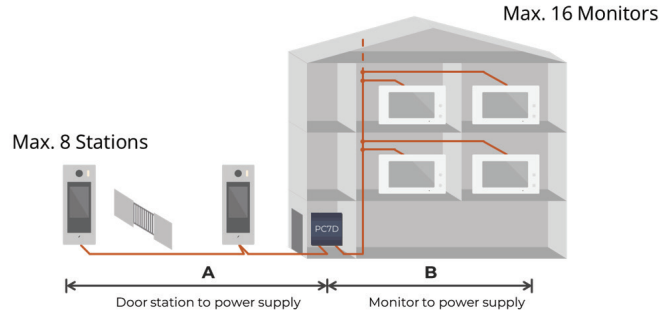

16 Monitoare	Tip Cablu	A (m)	B (m)
	2 x 0.75mm ²	60	90
	2 x 1.00mm ²	75	100
	Cablu UTP	40	40
	J-Y(St)Y2x2x0.6 / 1 per.	40	40
J-Y(St)Y2x2x0.6 / 2 per.	50	60	

32 Monitoare	Tip Cablu	A (m)	B (m)	C (m)
	2 x 0.75mm ²	60	90	90
	2 x 1.00mm ²	75	100	100
	Cablu UTP	40	40	40
	J-Y(St)Y2x2x0.6 / 1 per.	40	40	40
J-Y(St)Y2x2x0.6 / 2 per.	50	60	60	

48 Monitoare	Tip Cablu	A (m)	B (m)	C / D (m)	Cat5 (m)
	2 x 0.75mm ²	60	90	90	80
	2 x 1.00mm ²	75	100	100	80
	Cablu UTP	40	40	40	80
	J-Y(St)Y2x2x0.6 / 1 per.	40	40	40	80
J-Y(St)Y2x2x0.6 / 2 per.	50	60	60	80	

64 Monitoare	Tip Cablu	A (m)	B (m)	C / D / E (m)	Cat5 (m)
	2 x 0.75mm ²	60	90	90	80
	2 x 1.00mm ²	75	100	100	80
	Cablu UTP	40	40	40	80
	J-Y(St)Y2x2x0.6 / 1 per.	40	40	40	80
J-Y(St)Y2x2x0.6 / 2 per.	50	60	60	80	